

# Powermat 3000

The new flagship of the Powermat series







# WEINIG offers more

Whoever buys a WEINIG machine today knows that they are optimally equipped for the future of their business.

**100% quality** – WEINIG machines must satisfy the highest standards. That is why the greatest care in development and manufacturing is a traditional virtue at WEINIG. You benefit from this by the long service life of your valuable investment.

**Reliability** – The availability of a machine determines how profitable your business is. WEINIG systems are known for their high standard. More than 80,000 machines from WEINIG are operating around the globe to the utmost satisfaction of our customers.

**Expert advice** – Whether you need the expertise of WEINIG Concept for turn-key solutions or the know-how of a WEINIG expert at your door – you can always rely on our committed sales team. Ultimately you will have a customized solution that offers you maximum value for your investment.

**Everything from a single source** – With WEINIG you have an experienced full service provider as your partner. From rough cutting to stacking, from a stand-alone machine to a fully automated turnkey production line. Including, of course, a comprehensive service package.

**Service** – Safety is reassuring. If worse comes to worst, our trained service engineers will be quickly on site. WEINIG maintains a unique closely woven service network worldwide. A mesh so fine that no customer can fall through!

## The WEINIG ExpoCenter

In our ExpoCenter we can show you what top technology can really do for you. Here you can experience our machines in action.





Reliable, powerful, versatile:

# The new Powermat 3000

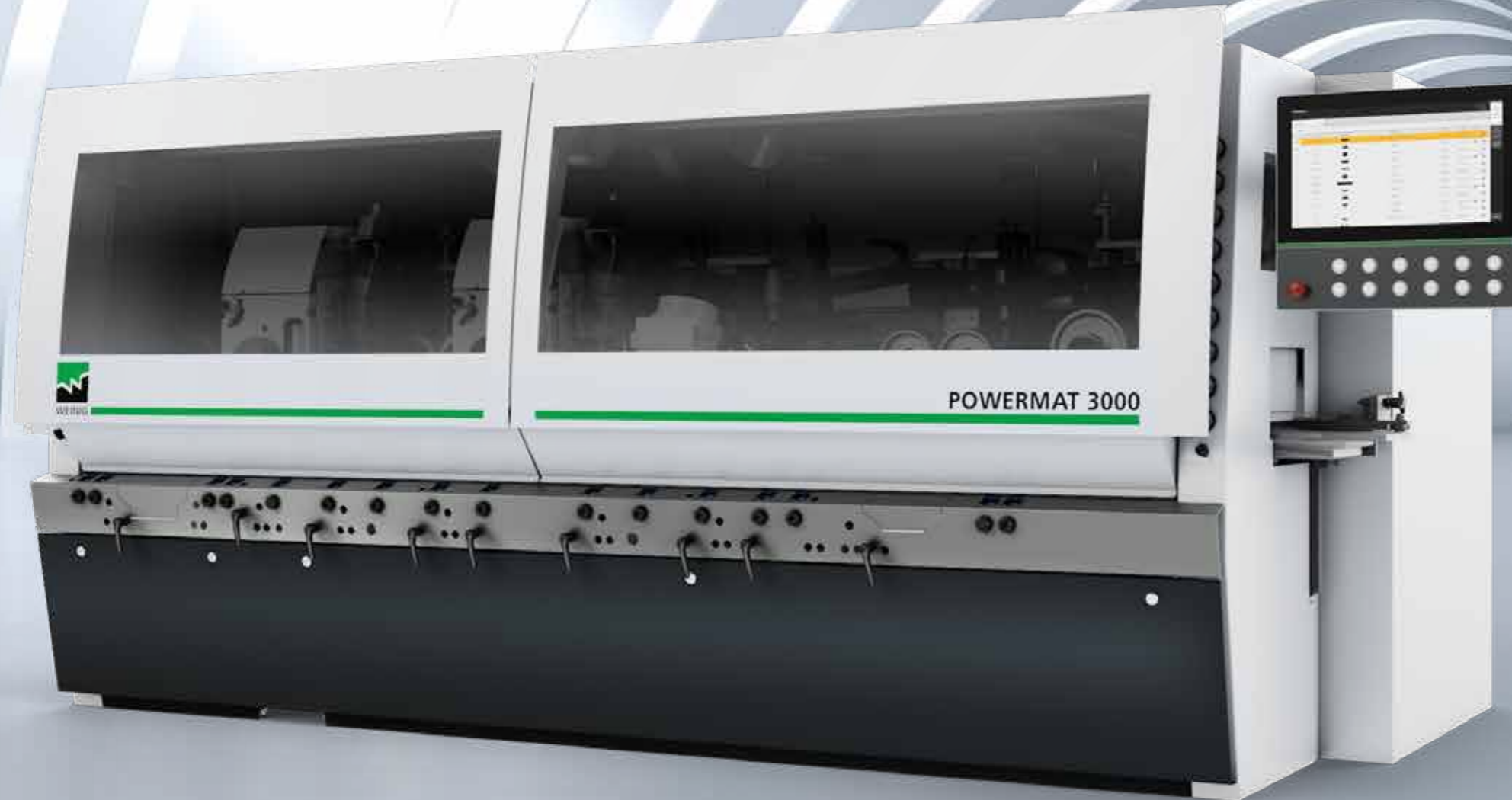

Know how, diligence and quality awareness: the synergy of all these factors emerge the Powermat 3000. Starting from the design of the valuable machine frame, via programming the intuitive machine control and the production of highly accurate spindles through to the precise assembly of all parts.

The Powermat 3000 provides optimum conditions for series production with the highest surface quality. The modular design and large number of options enables the most diverse applications. Not to mention excellent cost efficiency and resale value.

# Reliable: The extraordinary standards of the Powermat

The moulder is the heart of any production facility as it adds maximum value to the product. Independent from the application, the Powermat 3000 with a large, modular construction kit adapts itself individually to your requirements concerning quality, flexibility and performance. The foundation for this is the extraordinary standard of the Powermat 3000, which impresses with an intelligent machine concept.

Based on the heavy-duty cast iron frame high-quality components in combination with equipment for comfortable adjustments and an intuitive machine control result in a moulder which is easy to set up. For you, this means short set-up times, high operating safety, high machine availability and a very economic production – with the legendary WEINIG surface quality.

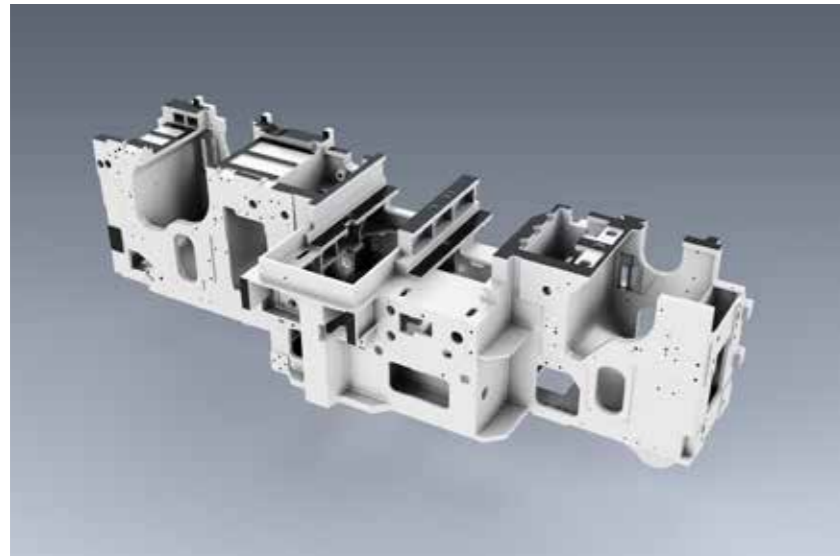

## High sturdiness

is guaranteed by the heavy-duty cast iron frame of the Powermat 3000: high precision is paramount here. Based on the robust machine frame, which was developed with modern computer-assisted tools, the high-quality components of WEINIG demonstrate their superiority. This results in minimum vibrations, high running smoothness and a surface with regular cuttermarks. In other words: workpieces which fulfil the highest demands in terms of accuracy and surface quality.

## 1. High wear resistance

The durable MarathonCoating ensures a high wear resistance of machine tables and fences as well as a safe transport of workpieces with minimum friction.

## 2. Excellent ease of operation

With the Comfort Set operating concept you have all trump cards in one hand: optimum accessibility and comfortable machine setting ensure a safe and fast setup with high-quality results.

## 3. Intuitive machine control

With the help of Memory Plus it is possible to perform dimensional or profile changes in the wink of an eye. All settings can be stored for perfect repetition of the product at a later date.

## 4. Highest surface quality

The quality of your end products depends on multiple factors. WEINIG has the required experience in guiding and processing the workpieces in order to produce the optimum surface quality.

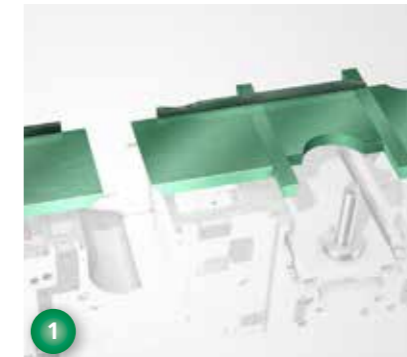



# Powerful: Gain more value from your business

With the new Powermat 3000 WEINIG offers an exceptional machine as a standard model. However, its full potential is not exploited by this. Essential leverage points are the feed system and the spindle technology. The modular design allows you to equip the machine also with a feed speed of up to 60 m/min (200 FPM) or even up to 100 m/min (330 FPM) – without sacrificing the surface quality. This is ensured by the sophisticated jointing technology, which makes it possible that all knives of a cutterhead produce the finished surface of the workpiece. A prerequisite for this is the use of hydro tools or of PowerLock tools.

The innovative WEINIG technology provides not only an increase of performance, but also a reduction of setup times, a decrease of rejects and a continuously high process reliability.



## 1. 4-roller infeed

Two feed rollers and two opposing table rollers ensure a robust feed of the workpieces.

## 2. Feed rollers

In combination with the feed speed of 100 m/min high running smoothness is guaranteed by the feed roller diameter of 170 mm (6.7").

## 3. High-performance packages

Robust spindle units provide high sturdiness and rigidity for heavy-duty applications.

## 4. Jointers moving with the spindle

In case of a radial spindle adjustment the jointers are automatically moving with the spindle and there is no manual setup required.

## 5. Adjustable table plate

The table plate is easy to adjust via an inclined plane and possesses a high solidity.

## 6. Automation

With an automated infeed and out-feed the full performance potential of the moulder can be exploited.



# Versatile: The range of applications

The variety of products in industrial series production is immense. However, no matter which market you are servicing, you will always have the right machine concept in the Powermat 3000. The Powermat 3000 offers you both a high-performance platform for the demanding requirements of everyday multiple shift operation as well as great flexibility.

So that your production is always cost-effective and in the legendary WEINIG quality. The Powermat 3000 is truly state-of-the-art technology in profiling. Here are just some examples of the vast range of applications.





# Useful options: More for your success!

WEINIG innovations have driven solid wood processing forward and set new benchmarks time and again. The new Powermat 3000 continues the tradition – to make your day-to-day work operations simpler, more productive and more profitable. With plenty of useful extras the Powermat 3000 can be adapted to your individual requirements. The scope of applications even goes beyond the processing of solid wood only.

WEINIG production technology is perfectly adapted to individual circumstances such as market situation, batch sizes and work flow procedures. From us you receive a solution that offers maximum return on investment. As a full service provider, we can also give you a total package so that you can organize the machine environment perfectly. From job preparation to the finished quality product.

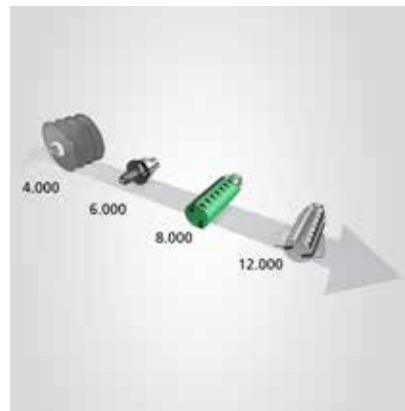

We perfectly gear the spindle speed to your application and your performance requirement in the range from 4,000 rpm to 12,000 rpm.

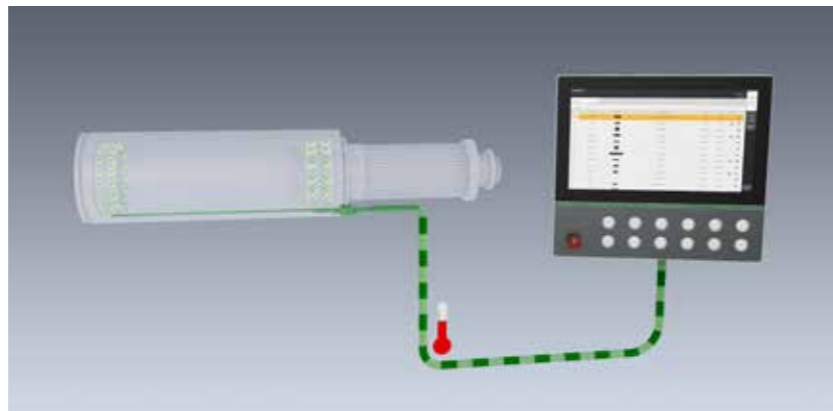

High production safety is achieved using the temperature monitoring of the spindles with the PowerCom Plus machine control. Thus, you always know all about the condition of the spindles and you are able to plan maintenance intervals at the right time. This avoids unplanned downtimes and increases the availability of your machine.



Extremely high performance yet surprisingly simple. Whether spindle related data, service checks or tool measurements PowerCom is the top solution for networking your Powermat 3000.

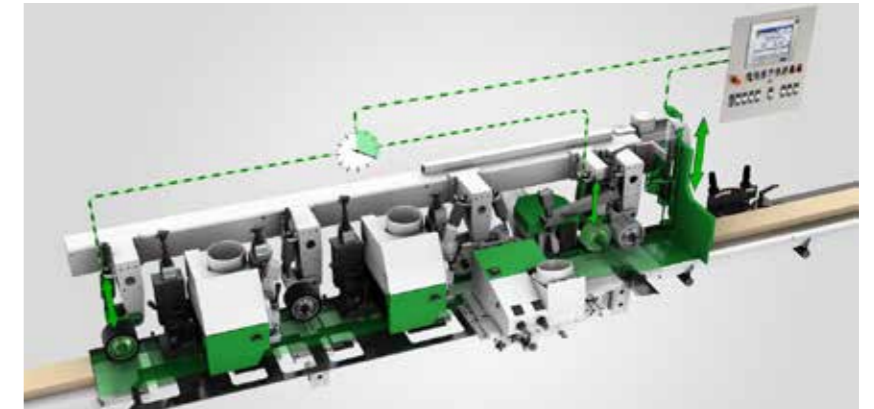

Using the workpiece monitoring, automatically detects whether there is a workpiece inside the machine or not. This allows dimensional changes while the machine is running – in combination with CNC-controlled axes for spindles and guiding elements even by pushing one button. You benefit from simple operating and time savings!

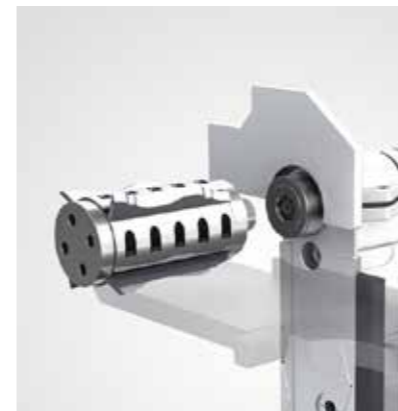

The patented PowerLock tool holder does not only enable tools to be changed by pushing one button, but also produces a brilliant surface finish thanks to a spindle speed of up to 12,000 rpm.

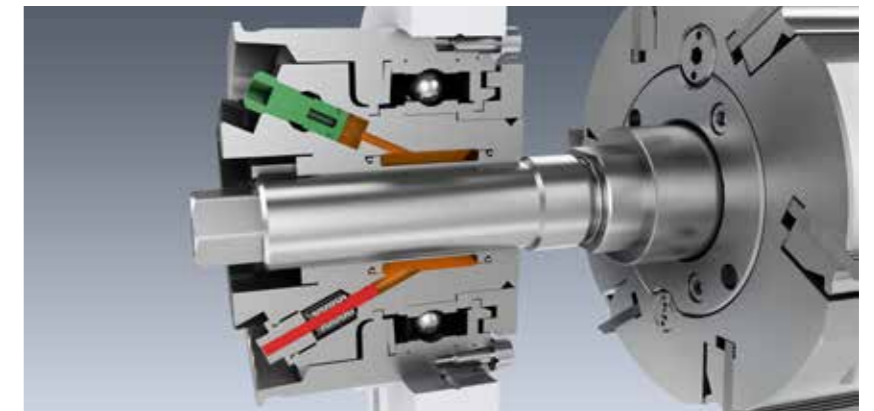

Thanks to the HydroLock outboard bearing the time-consuming setup using a grease gun is a thing of the past. Instead, all you need is an Allen key to densify the grease in the chambers and to build up the required pressure. There is a pin which serves as control of the clamping. The combination with HydroLock tools leads to a conclusive operating concept, which is simple and time-saving!

# WEINIG System Plus: The shortest way from an idea to the finished product

The WEINIG System Plus enhances your Powermat 3000 to become a highly efficient machining center that raises productivity. The individual system modules fit together like building blocks to produce the perfect result.

Particularly, when confronted with the challenges of quick delivery times, short production runs and satisfying individual customer requirements, WEINIG shows its competence – not only in reference to machine technology but also in consideration of the complete production infrastructure. From the profile drawing to the setup of your moulder. With the WEINIG System Plus you will meet the daily challenges with ease.

## Ideal for companies with

- large variety of profiles
- frequent profile changes
- single order processing
- multiple machines
- in-house tool grinding

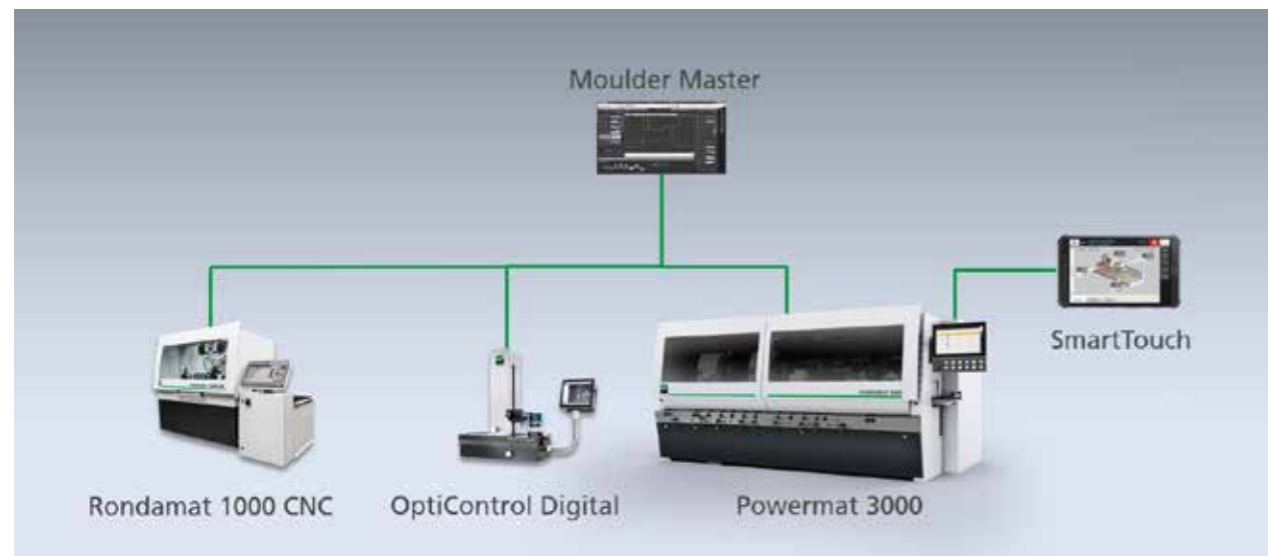

# Original WEINIG Tools: Your guaranty for perfect workpieces

The best machine only works as well as the tool it is equipped with. A high quality WEINIG moulder in combination with a precision tool produce top quality and performance. WEINIG offers you all the tools that are used for planing and profiling:

- PowerLock tools
- Hydro clamping
- Conventional tools

**The Rondamat Series** is our knife grinder for extreme precision in knife production. With the Rondamat you are able to manufacture and regrind profile and planer knives for any desired profile. Fast, exact and reasonably priced.

**Tool measuring and display systems** complete our tool grinding systems. This complete solution guarantees you the highest profile precision and at the same time enormous savings in set-up time.





# Technical data

WEINIG planers and moulders offer a variety of spindle configurations. This means that they can be specified perfectly to your particular application. The spindle sequences illustrated do not, by any means, cover all possibilities offered by our flexible modular frame system. Your WEINIG expert will be happy to advise you.

Please note: The dimensions given here are the values for a standard machine. Other measurements can result depending on options or alternative position of the control cabinet.

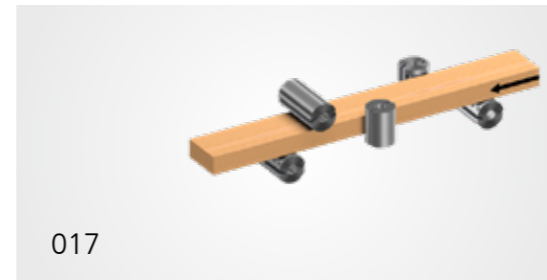
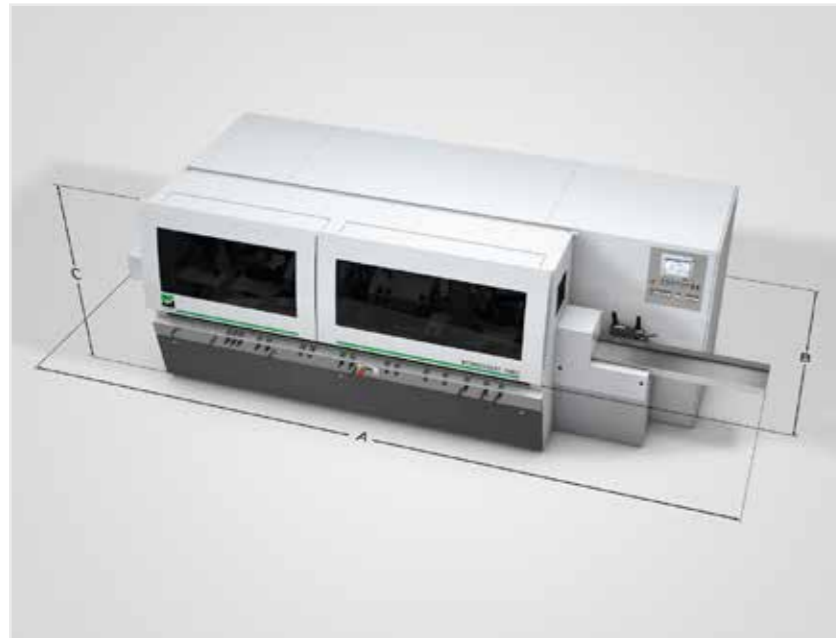

A = 4,500 mm (177.2"), B = 2,165 mm (85.2"),  
C = 1,905 mm (75")

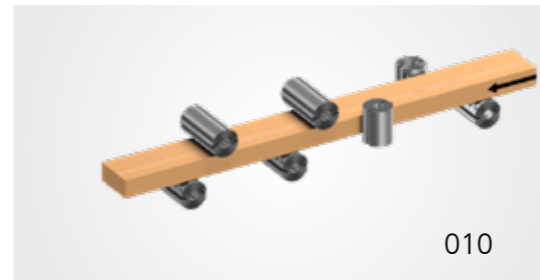

A = 5,350 mm (210.6"), B = 2,165 mm (85.2"),  
C = 1,905 mm (75")

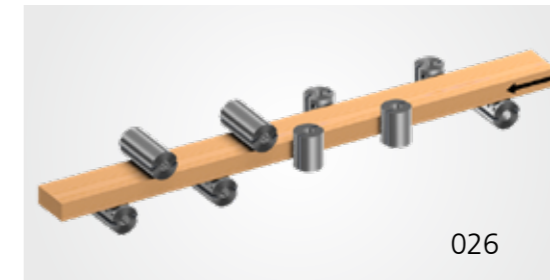

A = 6,200 mm (244.1"), B = 2,165 mm (85.2"),  
C = 1,905 mm (75")



A = 5,350 mm (210.6"), B = 2,165 mm (85.2"),  
C = 1,905 mm (75")

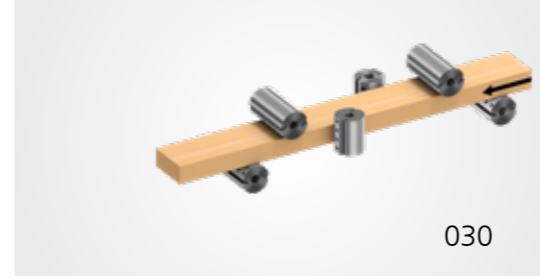

A = 5,350 mm (210.6"), B = 2,165 mm (85.2"),  
C = 1,905 mm (75")

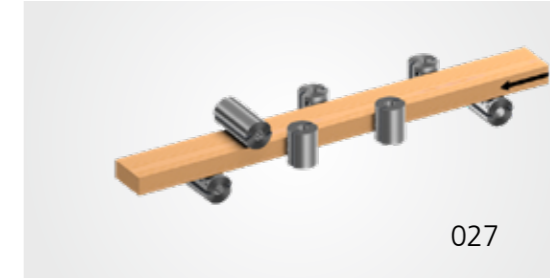

A = 5,350 mm (210.6"), B = 2,165 mm (85.2"),  
C = 1,905 mm (75")

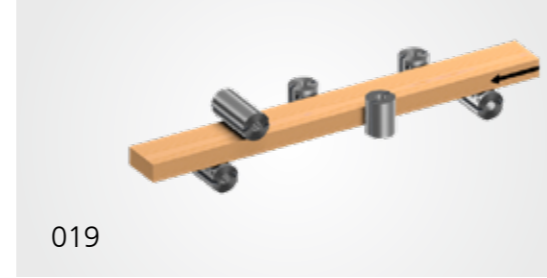

A = 4,850 mm (191"), B = 2,165 mm (85.2"),  
C = 1,905 mm (75")



A = 6,200 mm (244.1"), B = 2,165 mm (85.2"),  
C = 1,905 mm (75")

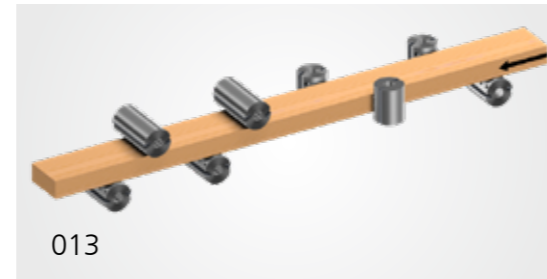

A = 5,700 mm (224.4"), B = 2,165 mm (85.2"),  
C = 1,905 mm (75")



A = 7,050 mm (277.6"), B = 2,165 mm (85.2"),  
C = 1,905 mm (75")

## Universal spindle

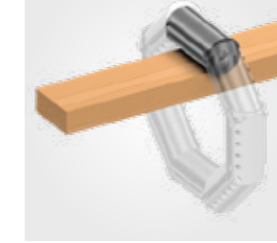

A = 850 mm (33.5"),  
B = 2,165 mm (85.2"),  
C = 1,905 mm (75")

A useful addition for the production of complex profiles in one pass. Flexible working positions on all 4 sides.

## Vertical splitting unit



A = 1,000 mm (39.4"),  
B = 2,450 mm (96.5"),  
C = 1,905 mm (75")

Planing and splitting in one process ensures top performance in production.

## Horizontal splitting unit

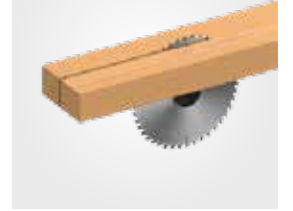

A = 850 mm (33.5"),  
B = 2,165 mm (85.2"),  
C = 1,905 mm (75")

The horizontal splitting unit adds the benefit of integrating a multi-blade rip saw into one process.

# Standard models and options

Working height min./max.	10/160 mm (0.39" - 6.29")
Working width min./max.	20/230 mm (0.78" - 9.05")
Working width 310 mm (12.20"), spindle speed max. 6,000 rpm with HydroLock outboard bearing	○
Working width 310 mm (12.20"), spindle speed max. 8,000 rpm with PowerLock	○
Maximum working dimensions	310 x 200 mm (12.20" x 7.87")
Operating concept Comfort Set	●
Spindle speed 6,000 rpm	●
Spindle speed 8,000 rpm / 12,000 rpm (10,000 rpm in connection with jointer)	○
Spindle speed 4,000 - 12,000 rpm, can be regulated electronically	○
Start and stop of all spindle drives via frequency converter	○
Memory Plus machine control	●
PowerCom Plus machine control	○
Max. horizontal tool diameter (except 1st bottom spindle)	250 mm (9.84")
Max. vertical tool diameter	250 mm (9.84")
PowerLock tool holders	○
HydroLock outboard bearings	○
Straight jointer / profile jointer, fully automatic	○
Frequency-controlled feed speed 5 - 40 m/min (16.4 - 131 FPM)	●
Frequency-controlled feed speed 6 - 60 / 8 - 80 / 10 - 100 m/min (200 / 260 / 330 FPM)	○
MarathonCoating for machine tables and fences	○
Max. motor power on vertical spindle (standard – option)	7.5 - 22 kW (10 - 30 HP)
Max. motor power on horizontal spindle (standard – option)	7.5 - 37 kW (10 - 50 HP)
Improved sound enclosure	○

Subject to technical alterations. The statements and pictures provided in this brochure also include optional equipment that is not included in standard delivery. Some protective covers were removed for photographing.

● Standard ○ Option

## You can expect big things from us: WEINIG – Your partner for the future.

### We are here for you.

Comprehensive advice – for example on optimum process integration of your new Powermat – is standard service at WEINIG as well as a well-tested training plan with effective training sessions. Our branches in all four corners of the earth and an extensive service team guaranty rapid help where and when you need us. As you see: WEINIG offers more.



Production line



Advice



Training



Service



## **MICHAEL WEINIG AG**

### **Product Unit Profiling**

Weinigstraße 2/4 · 97941 Tauberbischofsheim · Germany  
Phone +49 9341 86-0 · Fax +49 9341 7080  
info-profiling@weinig.com · www.weinig.com

